

Examination practice questions

You should have:

A ruler, protractor, compasses, a pen, pencil, eraser, calculator.
For some questions, you may need tracing paper.

Instructions

- Use **black** ink or ball-point pen.
- Answer the questions in the spaces provided – *there may be more space than you need.*
- **Calculators may be used.**

Information

- The marks for each question are shown in brackets.
- If the number of marks for two similar questions isn't the same, this is likely due to them being modelled on different specifications. In this case, it is worth considering both mark schemes.
- Use the number of marks for each question as a guide as to how much time to spend on each question. As a rough guide, you can multiply the number of marks by 1.2 to see how many minutes you should spend on a question.
- Questions will generally get more challenging as the document progresses. Some of the latter questions will go beyond the core grade level for this topic.

Advice

- Read each question carefully before you start to answer it.
- Don't forget to have fun.
- Check your answers at the end.

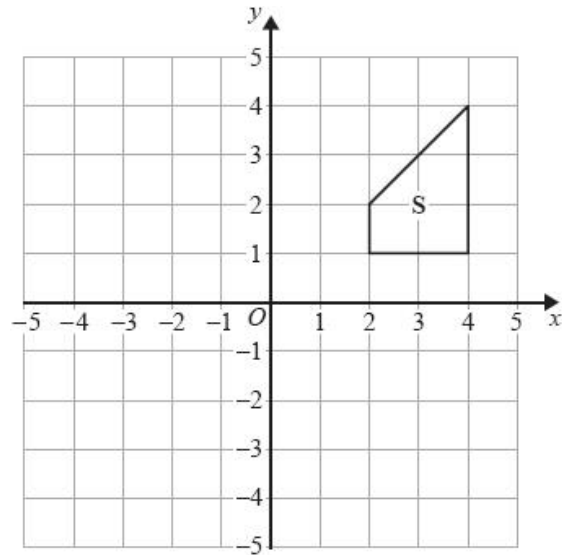

On the grid above, translate shape **S** by 1 square to the left and 3 squares down.

(2 marks)

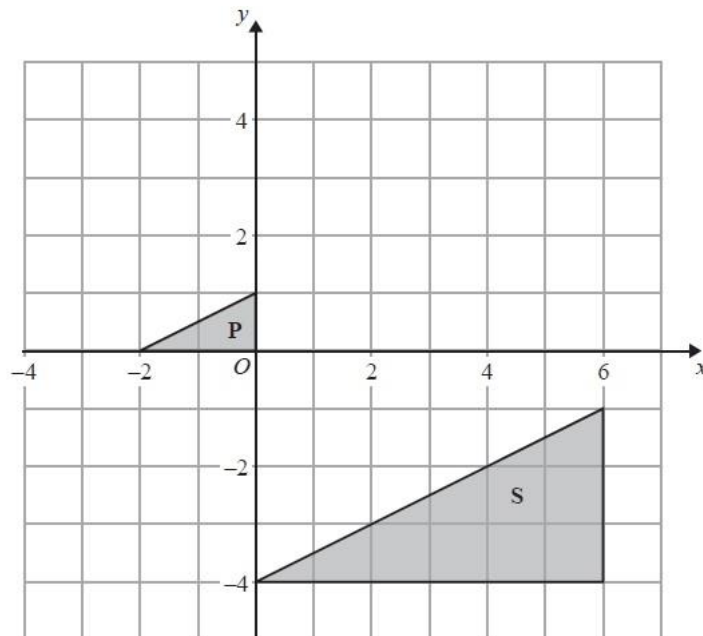

On the grid, translate triangle **P** 2 squares to the right and 1 square down.

(2 marks)

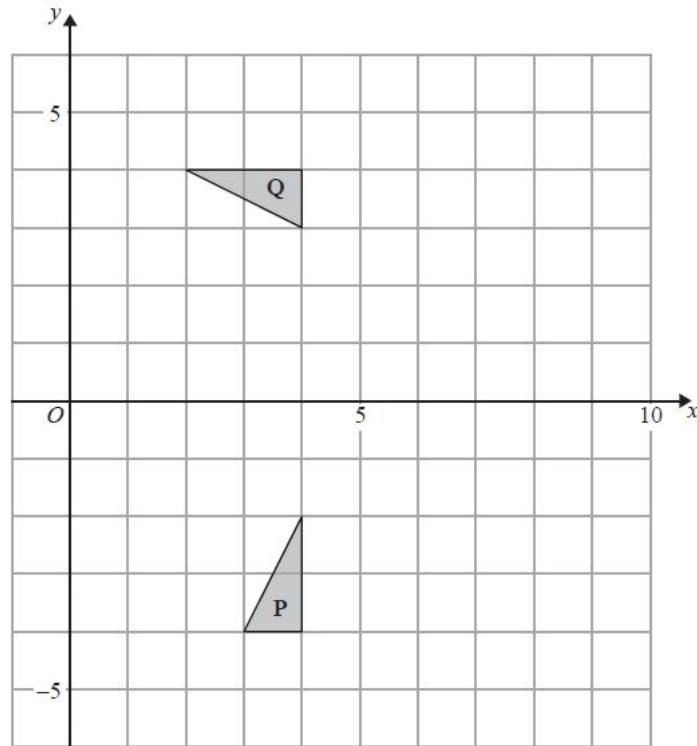

On the grid, translate triangle **P** 3 squares to the right and 5 squares up.
Label the new triangle **R**.

(2 marks)

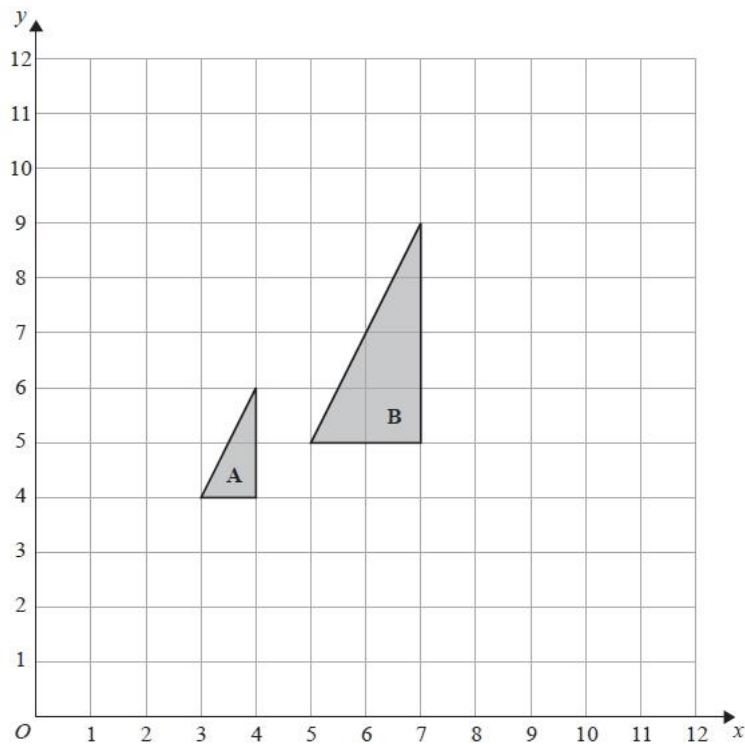

On the grid, translate triangle **A** 5 squares to the right and 2 squares down.

(2 marks)

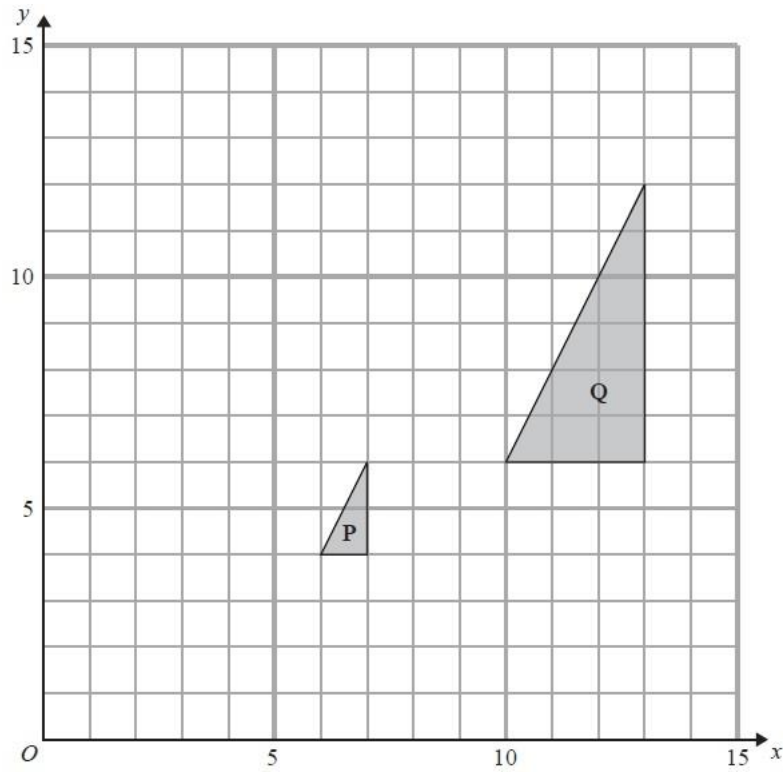

On the grid, translate triangle **Q** 8 units to the left and 2 units up.
Label the new triangle **R**.

(2 marks)

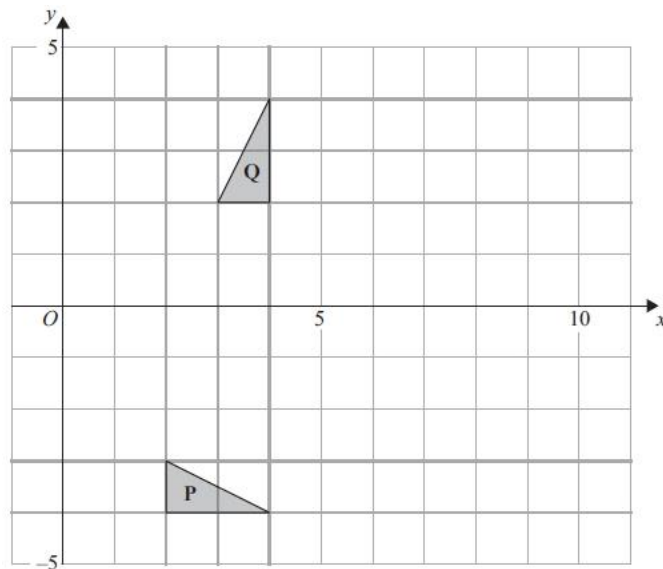

On the grid, translate triangle **Q** 4 squares to the right and 2 squares down.
Label the new triangle **R**.

(2 marks)

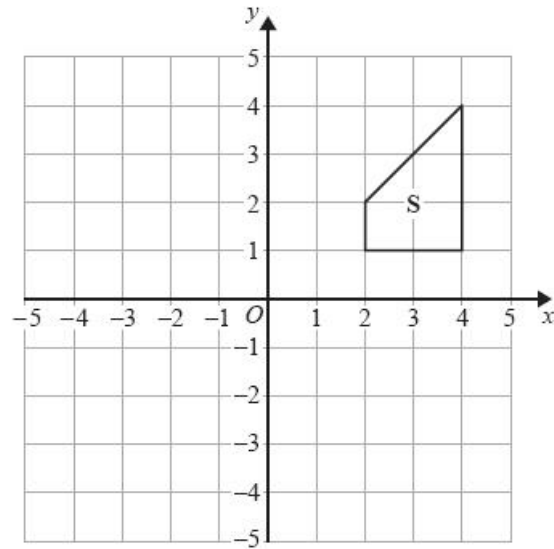

On the grid, translate shape **S** by the vector $\begin{pmatrix} -1 \\ -3 \end{pmatrix}$.

(2 marks)

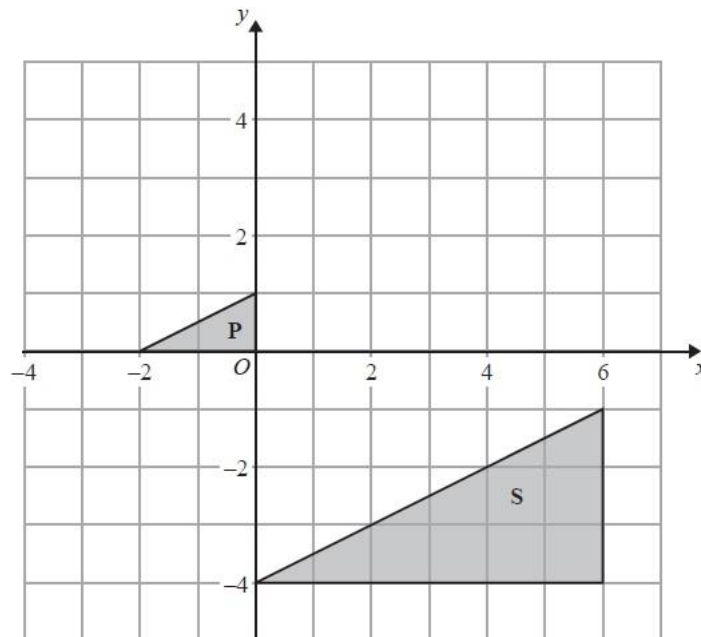

On the grid, translate triangle **P** by the vector $\begin{pmatrix} 2 \\ -1 \end{pmatrix}$

Label the new triangle **Q**.

(2 marks)

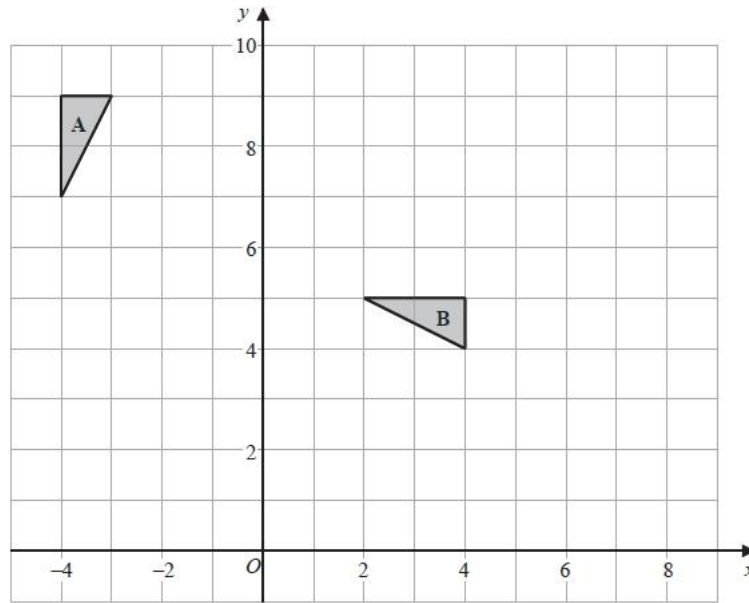

On the grid, translate triangle **A** by the vector $\begin{pmatrix} 2 \\ -5 \end{pmatrix}$

(2 marks)

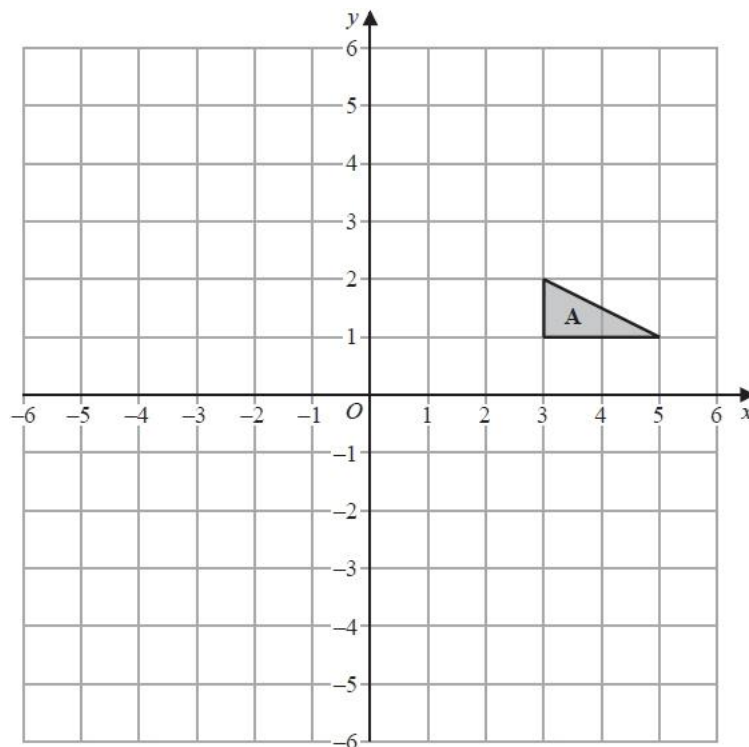

On the grid, translate triangle **A** by the vector $\begin{pmatrix} -7 \\ 3 \end{pmatrix}$

Label the new triangle **C**

(2 marks)

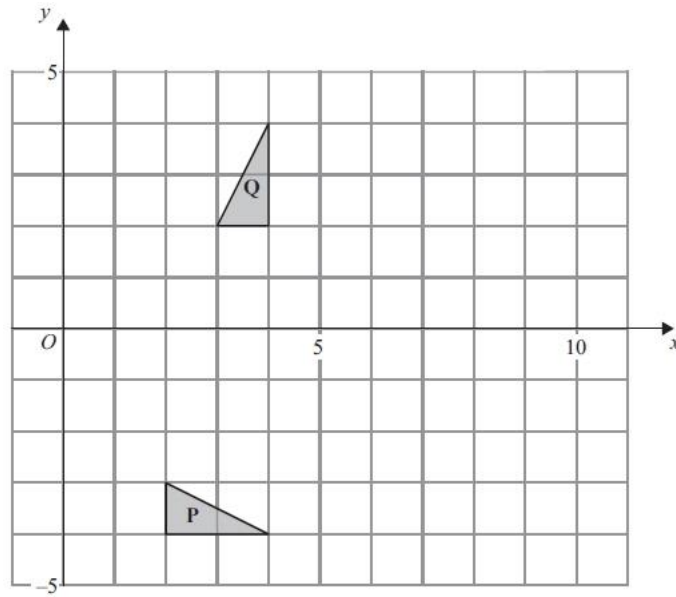

On the grid, translate triangle **Q** by the vector $\begin{pmatrix} 4 \\ -2 \end{pmatrix}$.
Label the new triangle **R**.

(2 marks)

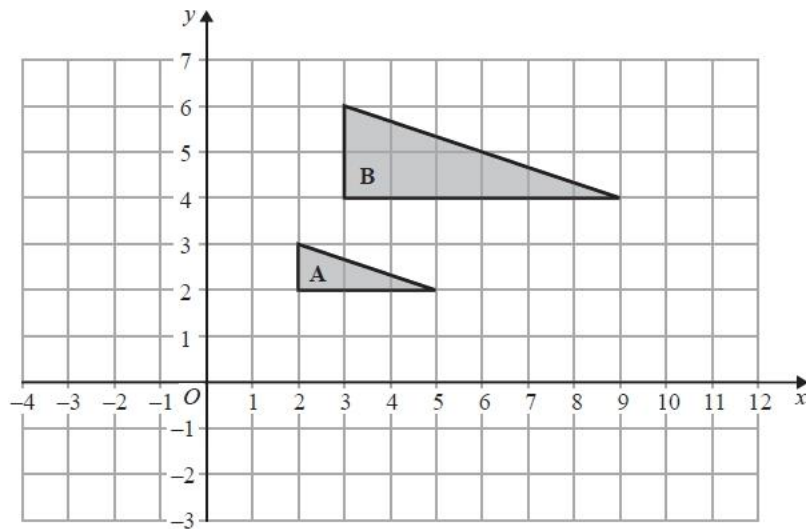

On the grid, translate triangle **A** by the vector $\begin{pmatrix} 5 \\ -4 \end{pmatrix}$.
Label the new shape **C**.

(2 marks)

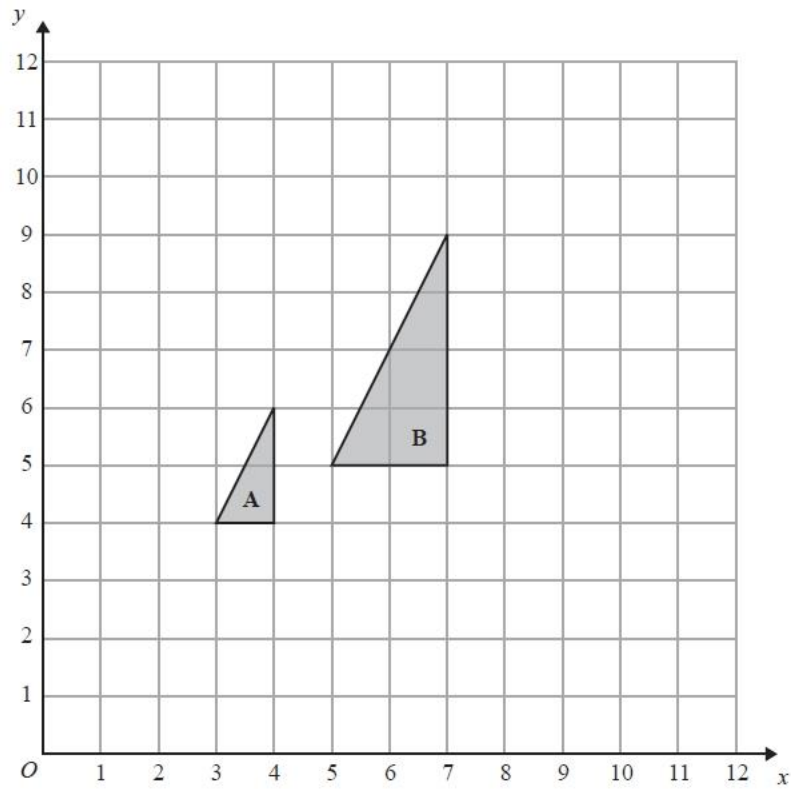

On the grid, translate triangle **A** by the vector $\begin{pmatrix} 5 \\ -2 \end{pmatrix}$

(2 marks)

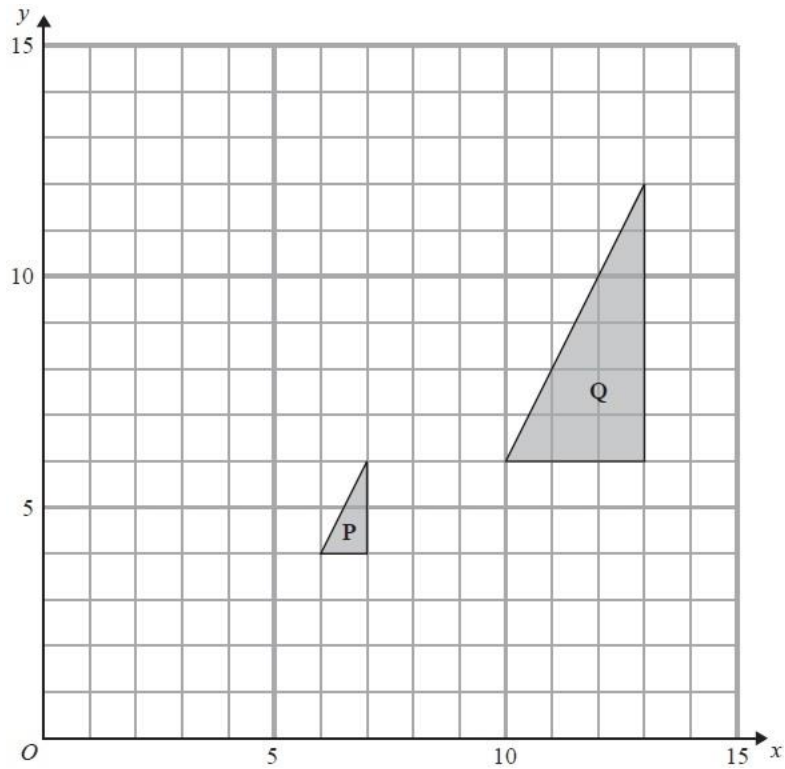

On the grid, translate triangle **Q** by the vector $\begin{pmatrix} -8 \\ 2 \end{pmatrix}$

(2 marks)

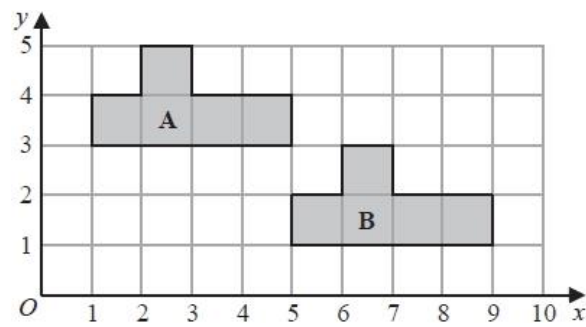

Describe fully the single transformation that maps shape **A** onto shape **B**

.....

.....

(2 marks)

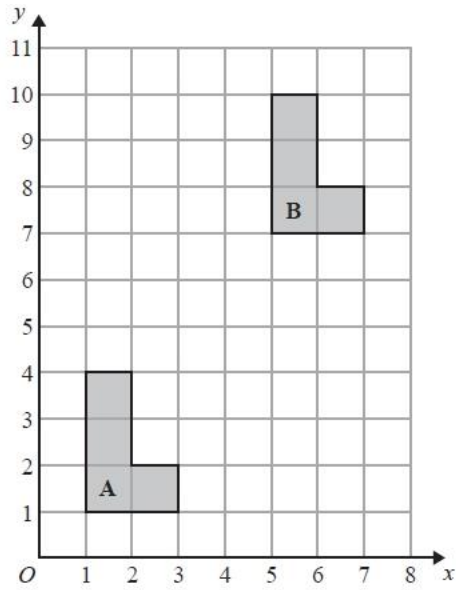

Describe fully the single transformation that maps shape **A** onto shape **B**.

.....

.....

(2 marks)

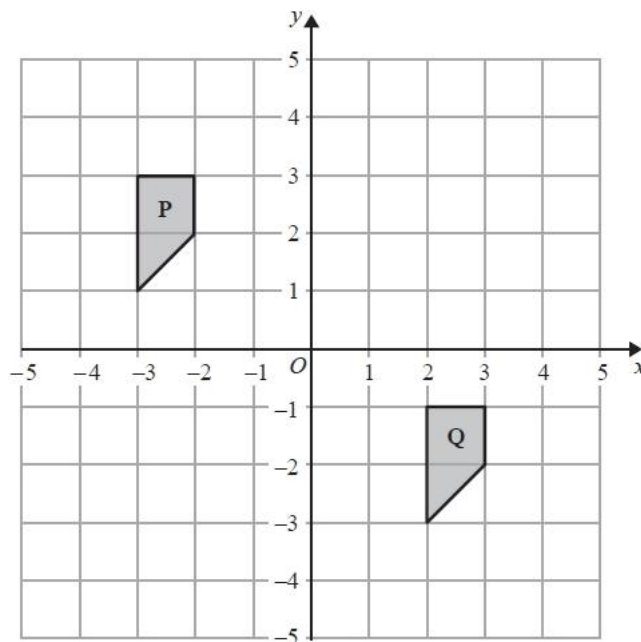

Describe fully the single transformation that maps shape **P** onto shape **Q**.

.....

.....

(2 marks)